

Atlas Concrete Products
1-800-774-1112

Road Divider 6 Feet

Note Available in 3', 6' or 12"

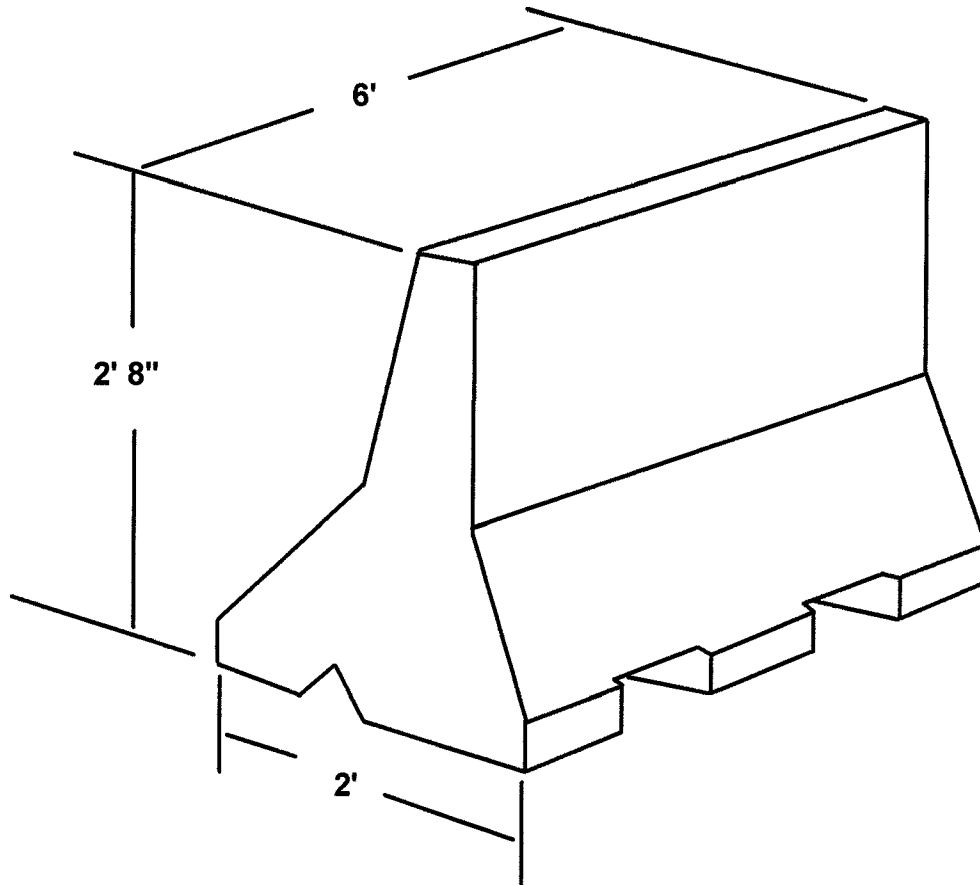

Notes

Concrete Compressive Strength
4,000 PSI @ 28 days

Weight 1500 Lbs